

Harman Kardon AVR70 Audio/Video Receiver

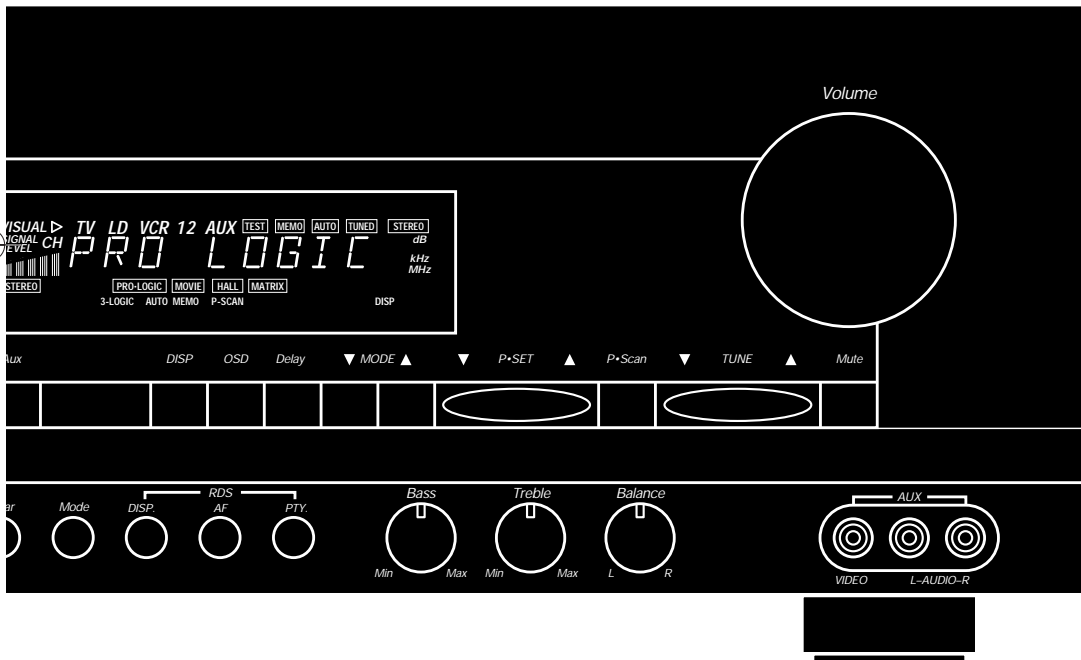

Owner's Manual

harman/kardon

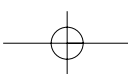
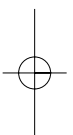
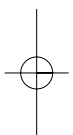
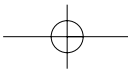

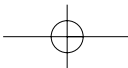

Front Panel

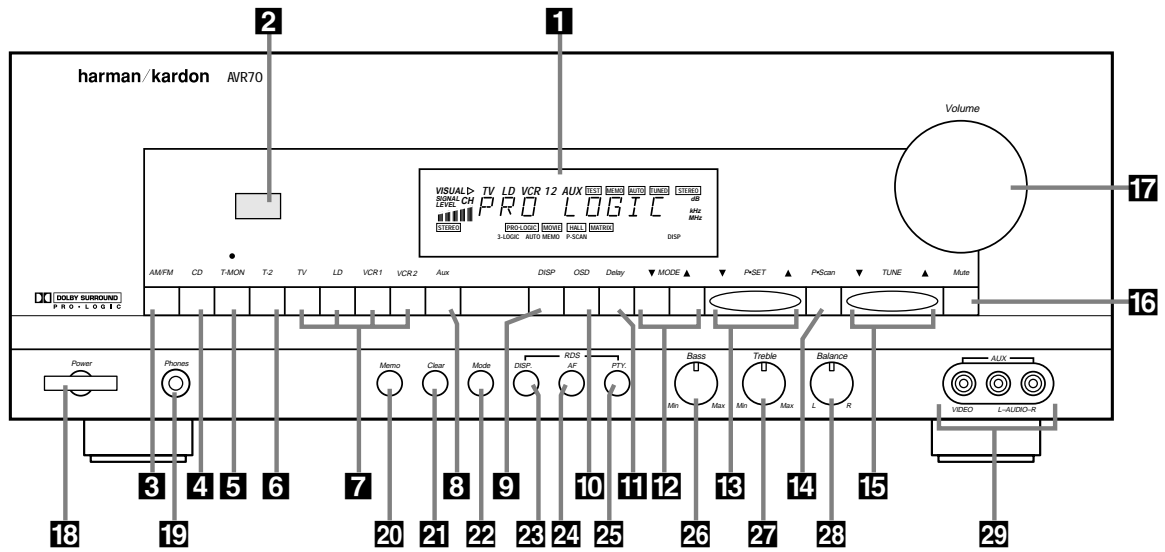

- | | | |
|-------------------------------------|--------------------------|-----------------------------------|
| 1 Information display | 11 Delay | 21 Clear |
| 2 Remote Sensor Window | 12 Mode | 22 FM Mode |
| 3 AM/FM Tuner Mode Selection | 13 Preset Tuning | 23 RDS Display |
| 4 CD | 14 P-Scan | 24 RDS Alternate Frequency |
| 5 Tape1/Monitor | 15 Tune | 25 RDS Programme Type |
| 6 Tape 2 | 16 Mute | 26 Bass |
| 7 Video Sources | 17 Volume Control | 27 Treble |
| 8 Aux | 18 Power | 28 Balance |
| 9 Display | 19 Headphone Jack | 29 Front Panel Inputs |
| 10 OSD (On Screen Display) | 20 Memo | |

Information Display

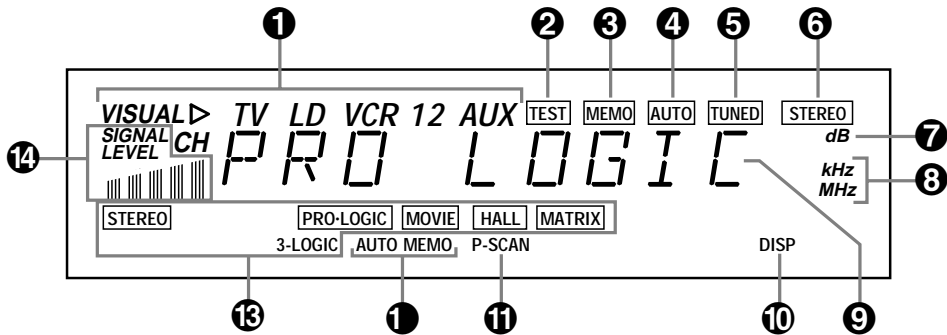

- | | | |
|------------------------------|-------------------------------------|-----------------------------------|
| 1 "Visual" Indicators | 6 Stereo | 11 P-Scan |
| 2 Test | 7 Volume Indication | 1 Auto Memo |
| 3 Memo | 8 Tuner Frequency Indication | 13 Mode Statue |
| 4 Auto | 9 Main Information Display | 14 Signal Level Indication |
| 5 Tuned | 10 Display | |

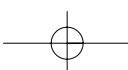

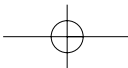

Rear Panel – Audio and System Connections

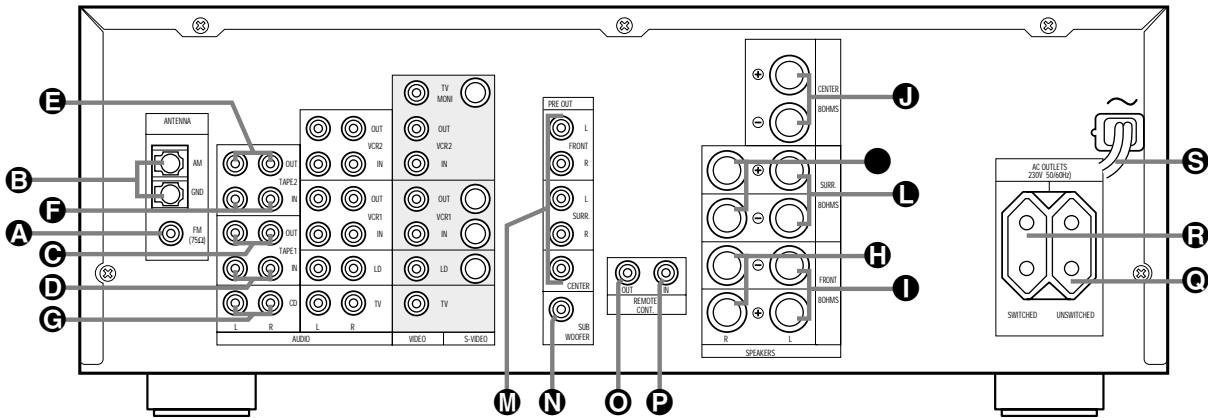

- A** FM Antenna
- B** AM Antenna
- C** Tape 1 Out
- D** Tape 1 In
- E** Tape 2 Out
- F** Tape 2 In
- G** CD IN

- H** Front R
- I** Front L
- J** Center
- K** Surround R
- L** Surround L
- M** Pre-Outs
- N** Subwoofer Pre-Out

- O** Remote IR Out
- P** Remote IR In
- Q** Unswitched AC Outlet
- R** Switched AC Outlet
- S** Power Cable

Rear Panel – Video Connections

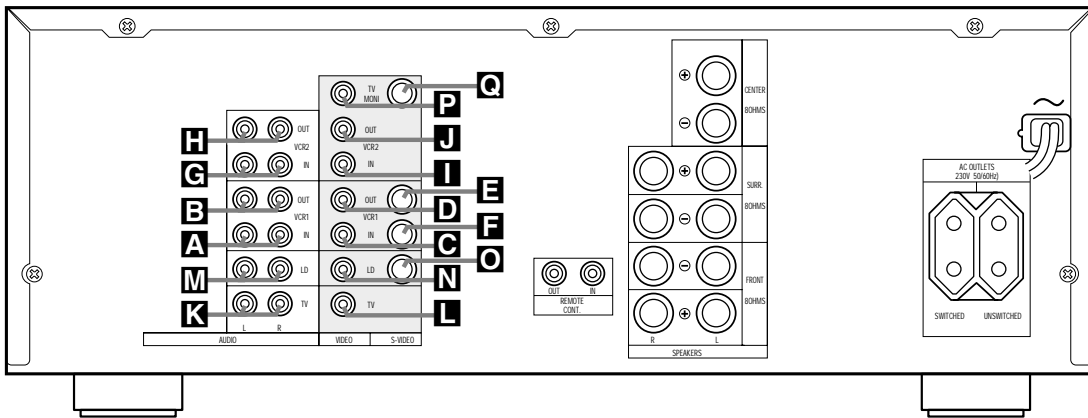

- A** VCR 1 Audio In
- B** VCR 1 Audio Out
- C** VCR 1 Video In
- D** VCR 1 Video Out
- E** VCR 1 S Video Out
- F** VCR 1 S Video In

- G** VCR 2 Audio In
- H** VCR 2 Audio Out
- I** VCR 2 Video In
- J** VCR 2 Video Out
- K** TV Audio In
- L** TV Video In

- M** LD Audio In
- N** LD Video In
- O** LD S Video In
- P** TV Monitor Video Out
- Q** TV Monitor S Video Out

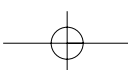

Remote Control

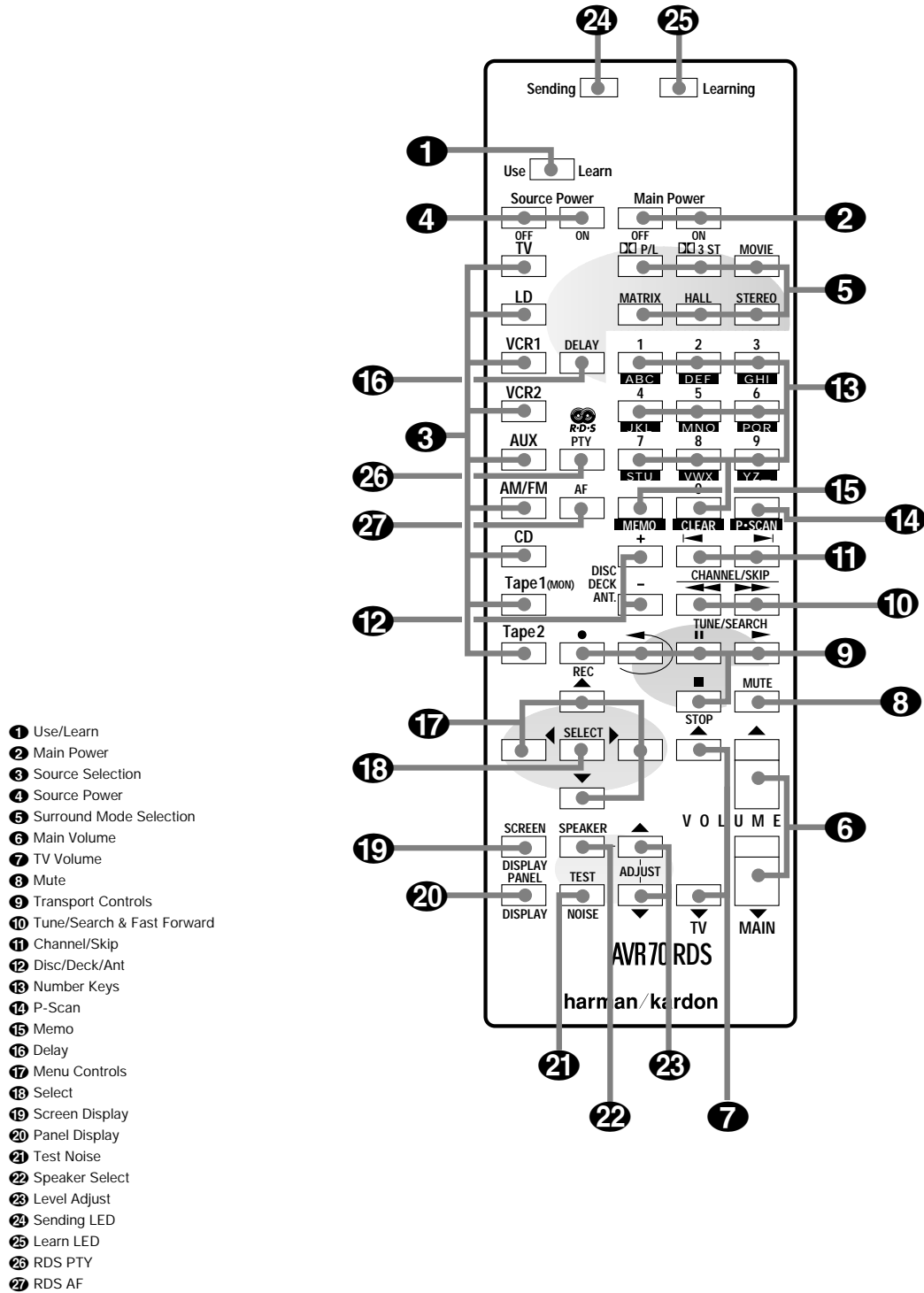

Table of Contents

Introduction	1
Features	1
Safety Information	2
Unpacking and Installation	3
Conventions	3
Front Panel Controls	4
Front Panel Information Display	5
Rear Panel Audio & Systems Connections	6
Rear Panel Video Connections	7
Remote Control Functions	8–9
Installation, Set Up and Configuration	10–11
Remote Control Programming and Operation ..	12–13
System Configuration	14–16
Basic Operation	17–22
Source Selection	17
Volume Control	17
Surround Mode Selection	17–18
TV Auto Function	18
Tuner Operation	18–20
RDS Operation	21–22
On Screen Display	23–24
Advanced Functions	25–26
Audio/Video Simulcast	25
Delay Time Adjust	25
Surround Mode Chart	26
Troubleshooting Chart	27
Technical Specifications	28

Introduction

1

ENGLISH

Congratulations! With the purchase of a Harman Kardon AVR70 you are about to begin many years of listening enjoyment. The AVR70 has been custom designed to provide all the excitement and detail of movie soundtracks and every subtle nuance of musical selections.

While complex digital systems are hard at work within the AVR70 to make all of this happen, hook-up and operation are simple. Color keyed connections, a comprehensive remote control and on screen menus make the AVR70 easy to use. To obtain the maximum enjoyment from your new receiver we urge you to take a few minutes to read through this manual. This will ensure that connections to speakers, source playback units and other external devices are made properly. In addition, a few minutes spent learning the functions of the various controls will enable you to take advantage of all the power the AVR70 is able to deliver.

If you have any questions about this product, its installation or operation, please contact your retailer or custom installer. They are your best local source of information.

Description and Features

The AVR70 is a full featured A/V receiver, incorporating a wide variety of listening options. In addition to standard Dolby® Pro Logic™ processing, the AVR70 uses Digital Signal Processing to provide other surround modes.

A total of five audio/video inputs, some with both composite and “S” video, as well as three additional audio only inputs are selected through a learning remote control and an easy to read front panel display or on screen graphics through a TV monitor.

The AVR70's powerful amplifier uses traditional Harman Kardon High Current design philosophies to meet the wide dynamic range of any program selection.

Harman Kardon invented the high fidelity receiver over forty years ago. With state of the art circuitry and time honored circuit designs, the AVR70 is one of the finest receivers ever offered by Harman Kardon.

- **Digital Signal processing for precise surround decoding**
- **Dolby ProLogic, Dolby 3 Stereo and three other surround modes**
- **On screen menu displays**
- **Learning remote control**
- **Composite and “S” video switching**
- **Preamp output for ALL channels permits ease of expansion**
- **“TV Auto” function simplifies remote operation of the AVR70 and a TV set**
- **RDS Programme Information System**



Safety Information

Important Safety Information

Verify Line Voltage Before Use

Your AVR70 has been designed for use with 220–240 volt AC current. Connection to a line voltage other than that for which it is intended can create a safety and fire hazard, and may damage the unit.

If you have any questions about the voltage requirements for your specific model, or about the line voltage in your area, contact your selling dealer before plugging the unit into a wall outlet.

Do Not Use Extension Cords

To avoid safety hazards, use only the power cord attached to your unit. We do not recommend that extension cords be used with this product. As with all electrical devices, do not run power cords under rugs or carpets or place heavy objects on them.

Handle the AC Power Cord Gently

When disconnecting the power cord from an AC outlet, always pull the plug, never pull the cord. If you do not intend to use the unit for any considerable length of time, disconnect the plug from the AC outlet (Attention: Than memory may be lost after some days).

Do Not Open The Cabinet

There are no user serviceable components inside this product. Opening the cabinet may present a shock hazard, and any modification to the product will void your guarantee. If water or any metal object such as a paper clip, wire or a staple accidentally falls inside the unit, disconnect it from the AC power source immediately, and consult an authorized service station.

Installation Location





- To assure proper operation, and to avoid the potential for safety hazards, place the unit on a firm and level surface. When placing the unit on a shelf, be certain that the shelf and any mounting hardware can support the weight of the product.
- Make certain that proper space is provided both above and below the unit for ventilation. If this product will be installed in a cabinet or other enclosed area, make certain that there is sufficient air movement within the cabinet. Under some circumstances a fan may be required.
- Do not place the unit directly on a carpeted surface.
- Avoid installation in extremely hot or cold locations, or an area that is exposed to direct sunlight or heating equipment.
- Avoid moist or humid locations.
- Do not obstruct the ventilation slots on the top of the unit, or place objects directly over them.

Cleaning

When the unit gets dirty, wipe it with a clean, soft dry cloth. If necessary, wipe it with a soft cloth dampened with mild soapy water, then a fresh cloth with clean water. Wipe dry immediately with a dry cloth. NEVER use benzene, aerosol cleaners, thinner, alcohol or any other volatile cleaning agent. Do not use abrasive cleaners, as they may damage the finish of metal parts. Avoid spraying insecticide near the unit.

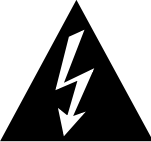
Moving The Unit

Before moving the unit, be certain to disconnect any interconnection cords with other components, and make certain that you disconnect the unit from the AC outlet.

	CAUTION RISK OF ELECTRIC SHOCK DO NOT OPEN	
<p>CAUTION: TO REDUCE THE RISK OF ELECTRIC SHOCK, DO NOT REMOVE COVER (OR BACK). NO USER-SERVICEABLE PARTS INSIDE. REFER SERVICING TO QUALIFIED SERVICE PERSONNEL.</p>		
	<small>The lightning flash with arrowhead symbol, within an equilateral triangle, is intended to alert the user to the presence of uninsulated "dangerous voltage" within the product's enclosure that may be of sufficient magnitude to constitute a risk of electric shock to persons.</small>	
<p>WARNING: TO REDUCE THE RISK OF FIRE OR ELECTRIC SHOCK, DO NOT EXPOSE THIS APPLIANCE TO RAIN OR MOISTURE.</p>		

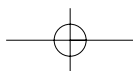

Safety Information

3

ENGLISH

Unpacking and Installation

The carton and shipping materials used to protect your new receiver during shipment were specially designed to cushion it from shock and vibration. We suggest that you save the carton and packing materials for use in shipping if you move or should the unit ever need repair.

To minimize the size of the carton in storage, you may wish to flatten it. This is done by carefully slitting the tape seams on the bottom and collapsing the carton down to a more two dimensional appearance. Other cardboard inserts may be stored in the same manner. Packing materials that cannot be collapsed should be saved along with the carton in a plastic bag.

If you do not wish to save the packaging materials, please note that the carton and other sections of the shipping protection are recyclable. Please respect the environment and discard those materials at a local recycling center.

How to Connect a Plug

The wires in the mains lead are coloured in accordance with the following code:

BLUE – “NEUTRAL” (“N”)

BROWN – “LIVE” (“L”)

1. The BLUE wire must be connected to the terminal which is marked with the letter “N” or coloured BLACK.
2. The BROWN wire must be connected to the terminal which is marked with the letter “L” or coloured RED.
3. Do not connect either wires to the earth terminal in the plug which is marked by the letter “E” or by the safety earth symbol \perp or coloured green or green-and-yellow.

Before replacing the plug cover, make certain that the cord grip is clamped over the sheath of the lead – not simply over the two wires.

Conventions

In order to help you use this manual with the remote control, front panel controls, rear panel connections and on-screen menus, certain conventions have been used.

EXAMPLE – (bold type) indicates a specific remote control or front panel button, or rear panel connection jack

EXAMPLE – (OCR type) indicates a message that is visible through the on-screen menu system

1 – (number in a square) indicates a specific front panel control

1 – (number in a circle) indicates an indicator in the main front panel display

1 – (number in an oval) indicates a button or indicator on the remote

A – (letter in a circle) indicates a rear panel Audio or System connection

A – (letter in a square) indicates a specific rear panel video connection

Front Panel Controls

4

1 Information Display: This display delivers messages and status indications to help you operate the receiver. Refer to the separate diagram for a complete explanation of the FL display.

2 Remote Sensor Window: The sensor behind this window receives infrared signals from the remote control. Aim the remote at this area and do not block or cover it unless an external remote sensor is installed.

3 AM/FM Tuner Mode Selection: Press this button once to select the tuner. Press it again to switch between FM, MW and LW.

4 CD: Press this button to select the CD player.

5 Tape1/Monitor: Press this button to select Tape One as the input source. A red LED above the button will illuminate to indicate that the Tape Monitor has been selected.

6 Tape 2: Press this button to select Tape 2.

7 Video Sources: Press any of these buttons to select a video input source.

8 Aux: Press this button to select the source connected to the front panel **Aux** jacks.

9 Display: Press this button to turn off the front panel FL display. The **DISP** indicator will illuminate to remind you that the unit is still turned on.

10 OSD (On Screen Display): Press the button briefly to display a system status report on your video screen. Press and hold to change the video standard.

11 Delay: Press this button to increase the delay to the rear (surround) channels.

12 Mode: Press these buttons to scroll up ▲ or down ▼ through the list of available surround modes.

13 P-Set: Press these buttons to manually scroll up ▲ or down ▼ through the FM, LW or AM stations programmed into the receiver's preset memory.

14 P-Scan: Press this button to automatically scan through the FM or AM stations preset into the receiver's memory. Press the button again to stop the scan when the tuner is at the desired station.

15 Tune: Press these buttons to manually or automatically scan up ▲ or down ▼ through the FM or AM bands.

16 Mute: Press this button to cut the output to the speakers. Press it again to return to the previous volume level.

17 Volume Control: Turn the knob clockwise to increase volume, counterclockwise to decrease the volume. Note that approximately two revolutions of the knob are required to go from no output to maximum volume.

18 Power: Press this button to turn the unit on or off.

NOTE: When the Power Switch is in the "OFF" position, the unit is in a "Standby" condition and is NOT disconnected from the AC mains supply.

19 Headphone Jack: Plug standard stereo headphones into this jack for private listening.

NOTE: When the headphones are in use the output to the speakers is muted and the surround mode is automatically switched to **STEREO**. When the headphones are removed from the jack, sound to the speakers is restored and the unit returns to the previous sound mode.

20 Memo: The memo button is used to enter stations to the tuner's preset memory in either the manual or automatic modes. It is also used in clearing the memory and entering the sleep timer period.

21 Clear: The clear button is used to cancel tuning, memory input or when clearing the unit's memories.

22 FM Mode: Press this button to select the receiving mode for FM stations (Stereo/Mono/Auto).

23 RDS Display: When a station transmitting RDS data is tuned, press this button to view the tuning frequency.

24 RDS AF: The button is used to search for stations transmitting a specific programme that may offer better reception than the currently tuned station.

25 RDS PTY: Press this button to view the programme type (PTY) when an RDS station is tuned. It is also used to initiate a search for RDS stations transmitting a specific programme type.

26 Bass: This knob adjusts the tone of low frequency sounds. Turn it to the right to boost bass frequencies or to the left to cut bass frequencies.

27 Treble: This knob adjusts the tone of high frequency sounds. Turn it to the right to boost high frequencies or to the left to cut high frequencies.

28 Balance: This knob adjusts the balance between the front left and right speakers.

29 Front Panel Inputs: Audio or Video sources connected to these jacks may be selected by pressing the **Aux** button **8**.



Front Panel Information Display

5

ENGLISH

1 "Visual" Indicator: These indicators display which video source is being fed to the video monitor output.

2 Test: This indicator flashes when the output levels are being set using the built in test signal generator.

3 Memo: This indicator flashes when the **Memo** button is pressed when entering presets and other information into the tuner's memory.

4 Auto: This indicator signifies that the Automatic Receiving mode (Stereo/Mono) is in use for FM broadcasts.

5 Tuned: This indicator lights when an AM or FM station is properly tuned and locked.

6 Stereo: This indicator lights when an FM station is broadcasting in stereo.

7 Volume Indication: The last two indicators on the information display indicate the volume level. Note that **0 dB** is the reference level, not an indication that there is no output.

8 Tuner Frequency Indication: When the tuner is in use, the main Information Display will show the preset channel number, if any, the frequency band and the station frequency. Indicators at the right side of the display show **kHz** when an LW or MW station is tuned or **MHz** when an FM station is tuned.

9 Main Information Display: This ten digit display shows messages relating to the status, input source, surround mode, tuner, volume level or other aspects of the unit's operation.

10 DISP: This indicator lights when the FL display has been turned off using the **Display** button **10** to remind you that the unit is still turned on.

11 P-Scan: This indicator flashes when the stations programmed into the tuner memory are being automatically reviewed.

12 Auto Memo: This indicator flashes when the tuner is automatically scanning for stations and entering them into the preset memory.

13 Mode Status: These indicators display the currently selected surround mode.

14 Signal Level Indication: This is a visual indication of the strength of a radio station signal. The more bars visible, the stronger the station.





Rear Panel Audio and System Connections

6

A FM Antenna: Connect an indoor or external FM antenna to these terminals.

B AM Antenna: Connect the AM loop antenna supplied with the receiver to these terminals. If an external AM antenna is used, make connections to the **AM** and **GND** terminals in accordance with the instructions supplied with the antenna.

C Tape 1 Out: Connect these jacks to the RECORD/INPUT jacks of an (3 head) audio recorder.

D Tape 1 In: Connect these jacks to the PLAY/OUT jacks of the same audio recorder.

E Tape 2 Out: Connect these jacks to the RECORD/INPUT jacks of a second audio recorder.

F Tape 2 In: Connect these jacks to the PLAY/OUT jacks of a second audio recorder.

G CD IN: Connect these jacks to the output of a compact disc player or CD changer.

H Front R: Connect these terminals to the front right speaker.

I Front L: Connect these terminals to the front left speaker.

J Center: Connect these terminals to the center speaker.

K Surround R: Connect these terminals to the right surround speaker.

L Surround L: Connect these terminals to the left surround speaker.

M Pre-Outs: If external power amplifiers are used for any channels, connect these jacks to the inputs of the amplifier.

N Subwoofer Pre-Out: Connect this jack to the line level input of a powered subwoofer. If an external subwoofer amplifier is used, connect this jack to the subwoofer amplifier input.

O Remote IR Out: This connection permits the IR sensor in the receiver to serve other remote controlled devices. Connect this jack to the "IR IN" jack on Harman Kardon or other compatible equipment.

P Remote IR In: If the AVR 70's front panel IR sensor is blocked due to cabinet doors or other obstructions, an external IR sensor may be used. Connect the output of the sensor to this jack.

Q Unswitched AC Outlet: This outlet may be used to power any AC device. The power will remain on at this outlet regardless of whether the AVR70 is on or off.

R Switched AC Outlet: This outlet may be used to power any device that you wish to have on when the unit is turned on.

NOTE: The power consumption of the device plugged into each of these outlets should not exceed 50 watts.

S Power Cable: Connect the AC plug to a non-switched AC wall output.

Rear Panel Video Connections

7

A VCR 1 Audio In: Connect these jacks to the audio PLAY/OUT jacks of a VCR.

B VCR 1 Audio Out: Connect these jacks to the RECORD/IN audio jacks of a VCR.

C VCR 1 Video In: Connect this jack to the composite video PLAY/OUT jack of a VCR.

D VCR 1 Video Out: Connect this jack to the composite video RECORD/IN jack of a VCR.

E VCR 1 S Video Out: Connect this jack to the "S" video RECORD/IN jack of a VCR.

F VCR 1 S Video In: Connect this jack to the "S" video PLAY/OUT jack of a VCR.

G VCR 2 Audio In: Connect these jacks to the audio jacks PLAY/OUT of a second VCR.

H VCR 2 Audio Out: Connect these jacks to the audio RECORD/IN jacks of a second VCR.

I VCR 2 Video In: Connect this jack to the composite video PLAY/OUT jack of a second VCR.

J VCR 2 Video Out: Connect this jack to the composite video RECORD/IN jack of a second VCR.

K TV Audio In: Connect the audio outputs of a TV, cable converter or satellite receiver to these jacks.

L TV Video In: Connect the composite video output of a TV, cable converter or satellite receiver to this jack. The signals received at this jack are also used to trigger the "TV Auto-On" feature.

M LD Audio In: Connect the audio output of a laser disc player to these jacks.

N LD Video In: Connect the composite video output of a laser disc player to this jack.

O LD S Video In: Connect the "S" video output of a laser disc player to this jack.

P TV Monitor Video Out: Connect this jack to the composite video input of a TV monitor or video projector to view the on screen control menus and output of the receiver's video switcher.

Q TV Monitor S Video Out: Connect this jack to the S video input of a TV monitor or video projector to view S video sources selected by the receiver's video switcher.

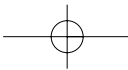

Remote Control Functions

8

- 1 Use/Learn:** This switch selects the operation mode of the remote control. Slide it to the left for normal operation. Slide it to the right when the remote is being programmed.
- 2 Main Power:** Press these buttons to turn the unit on or off.
- 3 Source Selection:** Pressing one of these buttons selects the input source that will be listened to through the receiver. When a source is selected the remote's transport and numeric number buttons will also transmit the commands needed to control that machine.
- 4 Source Power:** Press these buttons to control power for the last source device selected. This is effective only for devices with removable power (not TU930, HD730), for Tapes only with input Tape 1 (Monitor) unless programmed otherwise.
- 5 Surround Mode Selection:** Press one of these buttons to select a surround mode for the current listening session.
- 6 Main Volume:** These buttons control the unit's volume. Note that all channels are controlled simultaneously.
- 7 TV Volume:** These buttons adjust the volume for TV using the remote control codes programmed into the remote for a TV set or cable box. These buttons control the TV set only, regardless of which source is selected. This enables you to control the audio level of a TV set even when the receiver is not in use.
- 8 Mute:** Press this button to temporarily cut the audio output of the receiver. Press it again to return to the previous volume level.
- 9 Transport Controls:** These buttons control the tape or disc motion of the last playback source selected with the Source Selection buttons **3**. Use them as you would the Play, Stop, Pause, Reverse Play and Record buttons on any VCR, CD, cassette deck or LD remote control.
- 10 Tune/Search & Fast Forward:** (These buttons have multiple functions, which vary according to the input device selected.)
- When the **TUNER** has been selected, these buttons are used to tune stations.
 - When **CD, LD, Tape** or **VCR** is the input source, these buttons act as the Fast Scan Forward or Fast Scan Reverse controls.
- 11 Channel/Skip:** (These buttons have multiple functions, which vary according to the input device selected.)
- When the **TUNER** has been selected, these buttons will scroll up or down through the stations that have been programmed in the preset memory.
 - When **TV** or **VCR** is selected, they are the channel up or channel down tuning buttons.
 - When **CD** or **LD** is selected these buttons act as forward and reverse "Skip" buttons to move to the next track or chapter on the disc.
 - When a compatible Harman Kardon cassette player has been selected as **Tape 1** or **Tape 2**, these buttons move the tape forward or backwards to the next selection using the Music Scan feature.
- 12 Disc/Deck/Ant:** (These buttons have multiple functions, which vary according to the input device selected.)
- When **CD** is selected and the unit is a CD changer, these buttons will change to the next disc or previous disc .
 - When **Tape 1** or **Tape 2** is the input source, and the tape machine is a dual cassette deck, these buttons will switch between the "A" and "B" sides if programmed correspondingly.
 - When **VCR 1** or **VCR 2** is the input source, these buttons switch between tape and TV-tuner as the VCR's output.
 - When **TV** is the input source, these buttons may switch between video input sources or antenna/video, depending on the TV model.
 - When **LD** is the input source, these buttons will switch the side being played from "A" to "B" on compatible dual side players.
- 13 Number Keys:** These buttons serve as a ten button numeric keypad to enter tuner preset positions. They are also to be used to select channel numbers when **TV** has been selected on the remote, or to select track numbers on a CD or LD player, if CD or LD has been selected by the remote. The letters below the buttons are used to enter information for tuner station names.

NOTE: The **0** button has a dual function. It also serves as the **CLEAR** button for use in programming the tuner or clearing the system memory.

Remote Control Functions

14 P-Scan: Press this button to automatically scan through the stations preset into the tuner memory. Press the button again to end the scan when the tuner stops at the desired station.

15 Memo: The memo button is used to enter stations to the tuner's preset memory in either the manual or automatic modes. It is also used in the process of clearing the memory.

16 Delay: This button controls the amount of sound delay to the rear (surround) channels. Press it to increase the delay in the steps shown in the main Information Display or on-screen graphics.

17 Menu Controls: These buttons control the action of the cursor or the selection of menu items when the receiver is being configured using the setup menus.

18 Select: This button chooses a menu and enters settings to the receiver's memory during system configuration.

19 Screen Display: Press this button to activate the on screen menu system.

20 Panel Display: Press this button to turn off all displays and indicators in the Information Display except for a small **D I S P** indication in the lower right corner of the display **1**. Press the button again to turn the display back on. Note that the display will briefly illuminate when a command is sent to the unit from the front panel or remote, even though the display is turned off.

21 Test Noise: Press this button to begin calibration of the output level for each channel. A test signal will immediately be heard from the left front speaker and the **TEST** indicator **2** will flash.

22 Speaker Select: When setting the system output levels, this button selects the speaker position being adjusted. Press it once to advance to the next speaker after each position is adjusted.

23 Level Adjust: When setting the system output levels, press these buttons in increase or decrease the output level.

24 Sending LED: This indicator should flash any time a button is pressed to confirm that a command is being sent to the receiver or another unit. If the light is dim or does not illuminate when a button is pressed the batteries in the remote should be replaced.

25 Learn LED: This indicator will illuminate when a button on the remote is being programmed with signals from another remote during the "learning" mode. The light will go out when the signal is received and memorized.

26 RDS PTY: Press this button to view the Programme Type information for stations transmitting RDS data. This button is also used for PTY Auto Search functions.

27 RDS AF: This button initiates a search of alternative frequencies to find an eventually stronger signal for the station currently selected.

Installation, Set Up & Configuration

System Installation

After unpacking the unit, and placing it in on a solid surface capable of supporting its weight, you will need to make the connections to your audio and video equipment. These steps need to be done only when the receiver is first installed, or when a change is made to the input source equipment.





Audio Input and Output Connections

Use the "Audio and Systems Connections" Diagram in the inside front cover as a guide to connecting audio components and speakers to the rear panel. We recommend that you use high quality cables when making connections to source equipment and recorders to preserve the quality of the signals.

NOTE: When making connections to audio source equipment or speakers it is always a good practice to unplug the unit from the AC wall plug. This prevents any possibility of accidentally sending audio or transient signals to the speakers that may damage them.

1. For playback only sources, such as a CD player, CD changer, external phono preamp or external digital to analog converter, connect the output jacks of the player to the appropriately labeled inputs on the rear panel. 



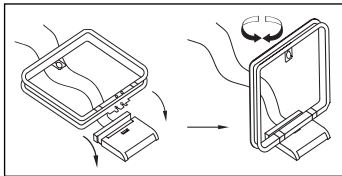

NOTE: When the source device has both fixed and variable audio outputs it is best to use the fixed output unless you find that the input to the receiver is so low that the sound is noisy, or high that the signal is distorted.

2. When connecting recording devices such as cassette recorders, open reel tape decks, DCC, DAT or MD, connect the PLAY/OUT jacks of the recorder to the **IN** jacks  . Connect the RECORD/IN jacks on the recorder to the **OUT** jacks  .

3. Assemble the AM Loop Antenna supplied with the unit as shown below. Connect it to the **AM** and **GND** screw terminals .



4. Connect an FM antenna to the **FM (75 ohm)** connection . The FM antenna may be an external roof antenna, an inside powered or wire lead antenna, or a connection from a cable TV system. Note that if the antenna or connection uses 300 ohm twin lead cable, you must use the 300 ohm to 75 ohm adapter supplied with the unit to make the connection.

5. Connect the front, center and surround speaker outputs     to the respective speakers.

To assure that all the audio signals are carried to your speakers without loss of clarity or resolution, we suggest that you use high quality speaker cable. Many brands of cable are available, and the choice of cable may be influenced by the distance between your speakers and this receiver, the type of speakers you use, personal preferences and other factors. Your dealer or installer is a valuable resource to consult in selecting the proper cable.

Regardless of the brand of cable selected, we recommend that you use a cable constructed of fine, multi-strand copper with a gauge of 14 or larger. Remember, that in specifying cable, the lower the number, the thicker the cable.

Cable with a gauge of 16 may be used for short runs of less than ten feet. We do not recommend that you use cables with an AWG equivalent of 18 or higher due to the power loss and degradation in performance that will occur.

Cables that are run inside walls should have the appropriate markings to indicate listing with appropriate testing agency standards. Questions about running cables inside walls should be referred to your installer or electrical contractor.

When connecting wires to the speakers, be certain to observe proper polarity. Remember to connect the "negative" or "black" wire to the same terminal on the receiver and the speaker. Similarly, the "positive" or "Red" wire should be connected to the like terminal on the AVR 70 and speaker.

NOTE: While most speaker manufacturers adhere to an industry convention of using black terminals for negative and red ones for positive, some manufacturers may vary from this configuration. To assure proper phase, and optimal performance, consult the identification plate on your speaker, or the speaker's manual to verify polarity. If you do not know the polarity of your speaker, ask your dealer for advice before proceeding, or consult the speaker's manufacturer.

Installation, Set Up & Configuration

11

ENGLISH

6. Connections to a subwoofer are made via a line level audio connection from the receivers jack **Ⓝ** to the line level input of a subwoofer with a built in amplifier. If a passive subwoofer is used, the connection first goes to a volume controlled power amplifier, which will be connected to one or more subwoofer speakers.

Video Input and Output Connections

Video connections are made in a similar fashion to those for audio components. Again, the use of high quality interconnect Video cables is recommended to preserve signal quality.

1. Connect the VCR's audio, video and "S" Video OUT jacks to the **VCR IN** jacks **A C F G I** on the rear panel. The audio, video and "S" video IN jacks on the VCR should be connected to the **VCR OUT** jacks **B D E H J** on the AVR70.

2. Connect the audio and video outputs of a satellite receiver, cable TV converter or television set to the **TV** jacks **K L**.

3. Connect the audio, video and "S" video outputs of a Laser Disc player to the **LD** jacks **M N O**.

4. Connect the **TV MON** **P Q** jacks on the receiver to the video or "S" Video inputs of your television monitor or video projector.

5. There is no mix or change between "Video" (composite) and "S" Video signals inside the AVR70 and no system selection. If watching to both signal systems, both **TV MON** jacks **P** and **Q** must be connected to the TV Monitor. The "On Screen" menus are visible only on the "Video" Output, not on "S" Video.

System and Power Connections

External Audio

Power Amplifier Connections

The AVR70 is designed for use with external power amplifiers too. These connections are easy to make during an initial installation, or at a later date should you choose to upgrade your system.

Using the **PRE OUT** jacks **Ⓜ**, connections may be made to external power amplifiers. Connect the **PRE-OUT** of the channels to be connected to external amplifiers to that amplifier's inputs. Volume will still be controlled by this receiver.

NOTE: When external power amplifiers are used, the center channel speakers should receive at least as much amplifier power as the front left and right speakers.

Remote Control Expansion

If the receiver is placed behind a solid or smoked glass cabinet door, the obstruction may prevent the remote sensor from receiving commands. In this event, an optional remote sensor may be used. Connect the output of the remote sensor to the **Remote Cont. IN** jack **Ⓟ**.

If other components are also prevented from receiving remote commands, only one sensor is needed. They may use this unit's sensor or a remote eye by running a connection from the **REMOTE CONT. OUT** jack **Ⓠ** to the Remote In jack on Harman Kardon or other JR-code compatible equipment.

AC Power Connections

This unit is equipped with two accessory AC outlets. They may be used to power accessory devices, but they should not be used with high current draw equipment such as power amplifiers (not more than 50 W each).

The **SWITCHED** **Ⓡ** outlet will receive power only when the unit is on. This is recommended for devices that have no power switch, or a mechanical power switch that may be left in the "ON" position (as f.e. with the h/k CDP HD730). Devices with electronic power switch may only switch on to standby mode, if plugged in here.

The **UNSWITCHED** **Ⓢ** outlet will receive power as long as the unit is plugged into a powered AC outlet.

Finally, when all connections are complete, plug the power cord into a non-switched AC wall outlet. Note that the ring surrounding the Power Switch **Ⓣ** will turn amber. You're almost ready to enjoy the AVR70!



Remote Control Programming & Operation

This product is equipped with a powerful remote control. As supplied, it will operate the receiver, as well as most CD players and tape decks manufactured by Harman Kardon. In addition, it is preprogrammed with the remote codes to operate VCRs, LD players and TV sets that are based on the popular RC-5 control code system. If your equipment requires different codes, it may be programmed to copy the codes from most infra red remotes.

Loading Batteries

The life of the batteries for the remote control is about one year in normal operation. If the green **Sending**  indicator does not flash when remote buttons are pushed, that is an indication that the batteries need to be replaced. Don't simply throw old batteries away but recycle only or return them to your dealer.

To change the batteries:

1. Remove the back cover by sliding it in the direction of the arrows.

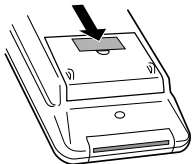

2. Remove the old batteries and insert fresh AAA type cells. Be certain to observe the correct polarity by noting the (+) and (-) marks on both the inside of the case and on the battery cells. It is recommended that both batteries be changed at the same time.

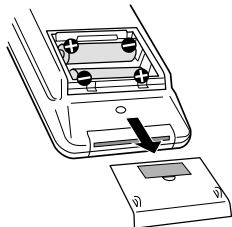

3. Close the cover until it clicks shut.

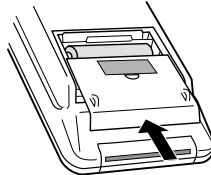

NOTE: It is important that the batteries be replaced within ten minutes after the old batteries are removed to avoid losing any remote codes that have been programmed into the remote's memory.

Remote Control Range

The remote will operate at a range of up to 5 meters from the unit, when the batteries are fully charged. The remote will also operate at an angle of up to 30° to either side of the unit.

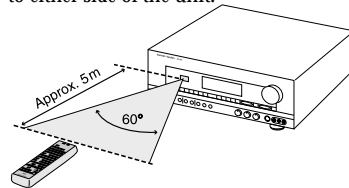

Always point the remote transmitter at the front of the unit when issuing commands. If you find that remote commands are not being received by the remote, it may be necessary to use a remote IR sensor.

Remote Programming

Programmable Keys

Many of the buttons on the remote control may be user programmed to new functions that operate virtually any component in your system. Ten **CANNOT** be programmed with a new code, as they control high level functions. These keys are **Main Power ON**, **Main Power OFF**, and the eight source input keys: **TV**, **LD**, **VCR 1**, **VCR 2**, **TUNER**, **CD**, **TAPE 1** and **TAPE 2**.

Programmable keys are divided into two groups. Some keys may be programmed with a separate function for each of the inputs. Thus, these keys may change their code when the input source is changed. (i.e. The **Play** key may transmit a different code when **CD** is selected as opposed to when **VCR** is selected.) The keys that may be programmed with multiple codes are the following:

All Numeric Keys (0 - 9)

Forward Play 

Source Power On

Reverse Play 

Source Power Off

Stop 

Disc/Deck 

Record 

Disc/Deck 

Pause 

Channel/Skip 

TV Volume Up 

Channel/Skip 

TV Volume Down 

Tune/Search 

Memo

Tune/Search 

P-Scan

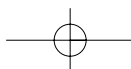

Remote Control Programming & Operation

Another group of keys may only be programmed with one remote code. The code contained in these keys remains the same regardless of the source selection.

WARNING: These keys transmit codes that are vital to the operation of the product. It is not recommended that they be programmed with alternative codes, as it may then be impossible to operate certain functions of the receiver.

Aux
 Cursor Up ▲
 Pro Logic
 Delay
 Cursor Down ▼
 Dolby 3 Stereo
 Memo
 Cursor Right ►
 Movie
 Screen Display
 Cursor Left ◀
 Matrix
 Panel Display
 Select
 Hall
 Speaker
 Main Volume Up ▲
 Stereo
 Test Noise
 Main Volume Down ▼
 Adjust
 Mute
 RDS PTY
 RDS AF

To program the remote, you need the remote of the device, whose functions shall be programmed. Note that it is not necessary to program all keys, only those that are required to operate the subject device. Keys not programmed will retain the codes preprogrammed at the factory.

1. Slide **Use/Learn** ❶ switch at the top left corner of the remote to the right so that it is next to **Learn**.
2. If one of the multi-function buttons is being programmed press the source button (i.e. **CD**, **VCR**, etc.) you wish to have this function associated with. If you are programming a single function key, proceed to the next step.
3. Press the button on the remote that is to be programmed. Note that the **Learning** ❷ LED will illuminate.
4. Place the remote head to head with the remote control whose function is being learned. The two remotes should be no more than 8 inches apart.
5. Press and hold the button on the transmitting remote corresponding to the function to be memorized until the **Learning** LED starts to blink. When the LED goes out, release the button on the transmitting remote. The function code has been successfully captured.

NOTE: If both LEDs flash during a programming operation, it indicates that the remote's memory is full or that the remote codes from the transmitting remote are not compatible with the unit's signal format.

6. Continue to program any additional remote commands required using steps 2 through 5. When you have finished programming the remote, slide the **Use/Learn** switch to the left so that it is in the **Use** position.

Clearing the Remote Memory

In normal operation, codes for a new device may be programmed "over" the codes that have been previously programmed into the remote. It is also possible to clear the memory for individual keys, or for the entire remote. When a memory position is cleared, the remote will return to the original factory preset command.

To clear the memory for a specific individual key location, put the **Use/Learn** switch in the **Learn** position. Press the **Main Power Off** ❷ button and the button to be cleared at the same time. Both the **Sending** and **Learning** indicators will light momentarily. When the lights go out, the memory has been cleared of the user programmed code and returned to the factory preset. Return the **Use/Learn** ❶ switch to the **Use** position when you are finished.

To clear the remote's entire memory and return all keys to their factory preset commands first put the **Use/Learn** ❶ switch in the **Learn** position. Then press the **Main Power On** button ❷ and confirm that the **Learning** indicator ❷ has illuminated. While continuing to press the **Power On** button, press and hold the **Power Off** ❷ button until the **Learn** indicator goes off for about 3 seconds. It will then blink twice. Then release the two buttons. This indicates that the memory has been cleared of any user programmed commands and that the original commands have been restored. Slide the **Use/Learn** switch back to the **Use** ❶ position to return the remote to normal operation.

System Configuration

When all audio, video and system connections have been made, there are a few configuration adjustments to be made. A few minutes spent to correctly configure and calibrate the unit will greatly add to your listening experience.

Speaker Selection and Placement

The placement of speakers in a multi channel home theater system can have a noticeable impact on the quality of sound reproduced. The AVR70 will deliver accurate reproduction with any high quality speakers.

No matter which type or brand of speakers are used, the same model or brand of speaker should be used for the front left, center and right speakers. This creates a seamless front soundstage, and eliminates the possibility of distracting sonic disturbances that occur when a sound moves across mis-matched front channel speakers.

For the most accurate and exciting reproduction of bass frequencies a separate subwoofer should be used.

Speaker Placement

For best imaging, it is recommended that the center channel speaker be placed in line with the left and right speakers. It should be placed above the center of TV monitor or rear screen projector, with the speaker as close to the top of the screen as possible. If possible, adjust the center channel speaker so that it is pointing towards the listening position. Once the center speaker is positioned, adjust the height of the left and right speakers so the

tweeter of those speakers is no more than 60 cm off center from the tweeter on the center channel speaker.

Surround speakers should be placed on the side walls of the room with the center portion of the speaker facing directly toward the listening area. The speakers should be located at a position along the side wall that is between one-half and two-thirds the distance from the viewing screen or the front of the room to the rear of the room. The speakers should be located so that the bottom of the cabinet is at least 60 cm higher than the listeners' ears when in the desired area.

If side wall mounting is not practical, the speakers may be placed on a rear wall, behind the listening position. Again, they should be located so that the bottom of the cabinet is at least 60 cm higher than the listeners' ears. The speakers should be no more than 2 m behind the rear of the seating area.

Subwoofers produce non-directional sound, so they may be placed almost anywhere in a room. Subwoofer placement is highly influenced by room size and shape, and the type of subwoofer used. Follow the instructions of the subwoofer's manufacturer, or experiment with the best location for a subwoofer in your listening room.

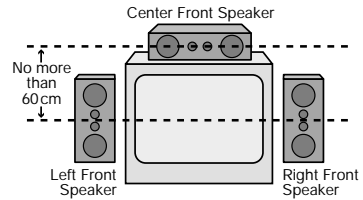

Front Channel Speaker Installation with Direct View TV Sets or Rear Screen Projectors

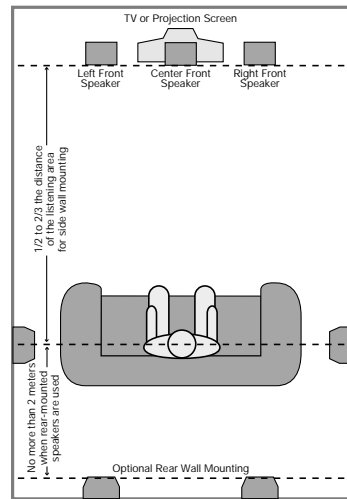

Speaker Placement Floor Plan

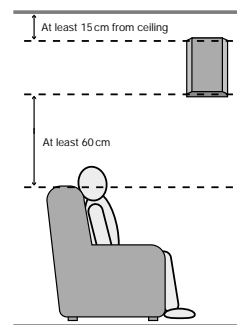

Surround Speaker Mounting Height

System Configuration

Once the speakers have been placed in the room and connected, the final step is to enter the configuration information and balance the speaker output levels. Before proceeding further this is a good time to review the installation section of the manual to make certain that all connections are properly made.

System Settings

1. Plug the unit into an AC wall outlet and press the **Power** button on either the front panel **13** or the remote **2**. Note that the ring surrounding the front panel switch will turn green, and the front panel display will illuminate.

2. Check to see that the unit is configured to the video broadcast standard in use in your country by pressing and holding the **OSD** button on the front panel **10** for more than three seconds. The front panel display will indicate the current setting. If the setting is not correct, if f.e. your picture is only black and white, press the button again until the correct standard (PAL, SECAM or NTSC) is displayed.

3. Turn on the TV connected to the receiver. Select the appropriate video input on the TV.

NOTE: Although the unit will switch "S" video signals, the on screen menus control system is NOT visible on the S video output.

4. Press any of the navigational arrow buttons or the **SELECT 18** button on the remote to bring the **MAIN MENU** up on your video screen. (Figure #1)

5. Press the **▼** button three times until the on screen **>** cursor is pointing to **SET UP MENU**. Press **SELECT 18**.

6. At the **SET UP MENU** (Figure #2), set the Center Channel Mode. The on screen **>** cursor will already point toward this option when you select the menu. Press the **◀** or **▶** buttons **17** to choose one of these center channel options by moving the cursor:

LARGE: Choose this option if you are using large size full range center channel speaker.

SMALL: Choose this option if the center speaker is small sized.

NONE: Choose this option if you are not using a center channel speaker.

7. When you have made a center channel selection, press **▼ 17** to move to the next option. Note that the **>** cursor should point to **SET UP LOCK**.

8. This option enables you to lock the configuration settings. This makes it difficult for someone to inadvertently change the settings by causing the word **LOCK** to appear at the top of the **SET UP MENU**. Before any further changes can be made, the user must first go to the **SET UP MENU** and unlock the system. Press the **◀** or **▶** buttons **17** to choose one of these options:

LOCK: Choose this option to lock the settings as described above.

UNLOCK: Choose this option to unlock the settings and enable them to be changed without going to this menu.

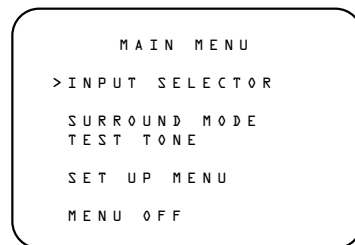

Figure 1

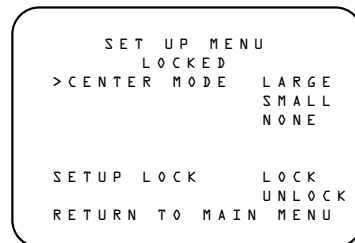

Figure 2

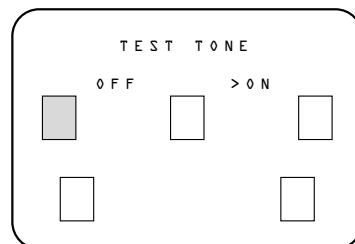

Figure 3

System Configuration

16

9. When you have made your choice, press **▼** **17** and then **SELECT** **18** to return to the **MAIN MENU**. At this point the output levels for all channels will be set to a reference so that the sound level is the same from each speaker. This compensates for the differences between the speakers used and the distance each speaker is from your listening position.

At this point you may wish to adjust the rear channel delay time. See the Advanced Features section later in this manual for information on delay settings.

NOTE: Before setting the output levels it is critical that the front panel bass **26** and treble controls **27** be set to their center, or "12 o'clock" position. This ensures accurate results.

10. At the **MAIN MENU**, press **▼** twice until the **>** cursor is next to **TEST TONE**. Press **SELECT** **18** to continue.

11. When you press **SELECT** you will immediately hear a test noise from the front left speaker. The on screen display will change to a graphic representation of each of the speakers in your room, with one speaker position blinking. (Figure #3, page 15) That speaker is the one whose level is being set.

NOTE: This procedure will only operate if the AVR70 is in the **PROLOGIC**, **MOVIE** or **DOLBY 3 STEREO** Modes. If the test tone cannot be selected, select **MENU OFF** in the **MAIN MENU** and check to see which surround mode is indicated in the front panel display. If it is not one of the modes mentioned above, select one of the correct modes, and then select the **MAIN MENU** point **TEST TONE** by pressing **▼** and **SELECT** on the remote to resume the set up.

12. While seated in the primary listening position in the center of the room, press **SPEAKER** **22** on the remote. Note that the sound should now come from the Center Channel speaker, and the icon for that speaker will flash on the screen. Use the **ADJUST ▲** and **ADJUST ▼** buttons **23** on the remote to change the level of the test noise so that it appears to be equal in level to the Front Left speaker.

13. Press the **SPEAKER** button again, and repeat the procedure for the Front Right and Surround channels. Each time, use the **ADJUST ▲** and **ADJUST ▼** buttons **23** on the remote to change the volume level so that all speakers match, and then press **SPEAKER** **22** to move to the next channel.

Subwoofers cannot be adjusted separately by the Menu system. If necessary adjust by the volume poti of the subwoofer amplifier.

NOTE: This test also serves as an opportunity to verify that all speakers are properly connected. If the sound from a speaker location does not match the location shown on the video and front panel displays, turn the AVR 70 off and check the speaker wiring to make certain that the speaker is connected to the correct output terminals.

14. When all speakers appear to have an equal volume, press the **◀** button **17** on the remote to complete the procedure.

NOTE: For a more accurate calibration of the speaker output levels perform the test outlined in steps 10 through 13 using a sound pressure level (SPL) meter. It is recommended that the output for each channel measure 75 dB (C-weighted, slow) on the meter.

CONGRATULATIONS! You have completed a basic set up and you are now ready to enjoy the finest in home theater and music listening enjoyment.

Basic Operation

17

ENGLISH

Once the input, speaker and antenna connections have been made, and the system has been configured, the receiver is ready for operation. Note that some controls are duplicated on both the front panel and the remote control, while others appear on one or the other, but not both.

To turn the unit on, press either the **Power** button on the front panel **13** or **Main Power ON** **2** on the remote. When power is turned on, the receiver will return to the input source in use when the unit was last turned on. The front panel display will also illuminate to provide status indicators of the unit's operation.

Source Selection

To select or change the input source, press one of the **Source** buttons on the front panel **3 4 5 6 7 8** or one of the **Source** buttons on the remote **3**.

To listen to one source while you watch another, first select the video source (**LD**, **TV**, **VCR1**, **VCR2** or **Aux**), and then select the desired audio source (**AM/FM**, **CD**, **Tape 1**, **Tape 2**).

The audio source will be displayed on the Information Display, while the video source will be displayed in the upper left corner of the Fluorescent Display next to the word **VISUAL** **1**.

Volume Control

The AVR70's volume is controlled using either front panel knob **17** or the **Main Volume** buttons **6** on the remote.

NOTE: Unlike conventional mechanically driven volume controls, this receiver's volume is set using digital devices. This means that the volume knob has no firm stopping point at either end of its rotation. Depending on the speed with which the knob is turned, it is normal for as many as three complete rotations to be required for full travel from the loudest setting to the softest.

When the volume is adjusted, the word **Master** will appear in the main portion of the Information Display, followed by a two digit number. The number indicates the variation from the reference point established when the output levels are set.

Surround Mode Selection

One of the most important features of the AVR70 is its ability to reproduce a full multichannel surround soundfield from both surround encoded programs, and standard stereo programs.

Selection of a surround mode is based on personal taste, as well as the type of program source material being used. For example, motion pictures bearing the logo of one of the major surround encoding processes, such as Dolby Surround, DTS Stereo™ or UltraStereo may be played in either the Dolby Pro Logic, Dolby 3 Stereo or Movie Surround Modes. Other mode selections are described elsewhere in this manual.

NOTE: Once a program has been encoded with surround information, it

retains the surround matrix as long as the program is broadcast in stereo. Thus, movies with surround sound will carry surround information when they are broadcast via conventional TV stations, cable, pay TV and satellite transmission in stereo. In addition, a growing number of made for television programs, sports broadcasts, radio dramas and music CDs are also recorded in surround sound. You may obtain a list of these programs and discs from Dolby Laboratories Licensing Corp., Woothon Bassett, Wiltshire, SN4 8QJ, England.

Surround modes may be selected in one of three ways.

From the front panel, use the **Mode** **▲** or **Mode** **▼** buttons **12** to scroll through the list of modes. The selected mode will appear in large letters in the front panel display, and in a two line reminder on the video screen. Once the selection is made, the mode will continue to appear in a smaller indicator at the bottom of the front panel display.

From the remote, modes may be selected by simply pressing the button that corresponds to the desired mode. **5**

Modes may also be selected using the on screen display. Press **SELECT** **13** on the remote to display the **MAIN MENU**. Then press **▼** **17** once so that the on screen cursor is next to **SURROUND MODE**. Press **SELECT** **13** again to move to the next menu.

Basic Operation

18

At the **SURROUND MODE MENU**, press the ◀ or ▶ buttons **13** until the desired mode name appears on the screen. Press ▼ twice until the > cursor is next to **RETURN TO MAIN MENU** and press **SELECT**. At the main menu select **MENU OFF** and press **SELECT** to exit the menus.

A different mode may be selected for audio and video sources. Once a mode has been selected, it will be attached to those sources in memory. Thus, you may select **PRO LOGIC** as the mode for video and **HALL SURROUND** for audio. After the initial selections are made, the unit will automatically return to your preferred mode for each type of input whenever it is chosen.

TV Auto Function

With the increasing sophistication of today's home entertainment systems, it often takes numerous remote controls to turn a system on. This receiver's unique "TV Auto" feature simplifies that task and greatly reduces the actions needed to bring your entire system to life.

If a video feed is connected to the **TV VIDEO IN** jack **14** during the installation, that signal is used to trigger system turn on. Even when the receiver is turned off, the presence of a signal at the **TV VIDEO** jack will automatically cause the receiver to turn on. As long as the signal is present, the receiver will remain on. When the TV or other source is turned off, the receiver will automatically return to a standby ("off") mode within five minutes.

Note that if the receiver is turned on automatically by this function, it will remain on if another source is subsequently selected. In that case, the receiver needs to be turned off manually even if the TV source is turned off.

Tuner Operation

The FM/AM tuner is extremely flexible, and offers a number of options. The following instructions will enable you to take advantage of the tuner's many features.

To select tuner operation, press the **AM/FM** button **3** on the front panel, or the remote **3**. Press the button again to select the desired frequency band if required.

Manual up/down tuning is accessible by pressing the **TUNE** button **15** either up ▲ or down ▼ or the Tune/Search ◀◀ and Tune/Search ▶▶ **10** buttons on the remote. Pressing these buttons once increases or decreases the station frequency by one step. Holding the buttons down quickly scans for the next station. Holding the tune buttons for a few seconds and then releasing them, automatically will set the tuner to the next station with an acceptable signal.

When manually tuning stations, observe the **SIGNAL LEVEL** indicator **16** and the **TUNED** **5** indicators. The more bars visible on the **SIGNAL LEVEL** indicator, the stronger the signal and the better the station will sound. A station is properly tuned when the **TUNED** indicator is illuminated.

Tuner Mode

Pressing the **FM Mode** button **22** on the front panel selects how a station will be received. When the button is pressed so that the **AUTO** **4** indicator is lit, stations broadcasting in stereo will be received in stereo. You may note stereo broadcasts by observing that the **STEREO** **6** indicator will illuminate. When the **FM Mode** button **22** is pressed until the **AUTO** **4** light goes out, all stations will be received in a monaural mode regardless of the method of transmission.

NOTE: When a station is broadcasting in stereo, but has a weak signal level, the reproduction may not be acceptable. In this case, select the Auto Off mode, as monaural reception is less susceptible to noise in weak reception areas.

Tuner Presets

There are thirty preset positions that may be used to store your favorite stations in any order. These may be used to memorize the station's frequency, reception mode and the station's name. Stations may be preset automatically or manually, and then recalled in a variety of ways.

Automatic Station Preset Selection

This process automatically scans the AM and FM bands and enters all stations with proper signal strength into the memory. To automatically preset the tuner's memory, follow these steps:

1. Select the tuner as the unit's input by pressing the **AM/FM** button **3** **3**.
2. Using the **TUNE** **15** **10** buttons, select the first station you wish to preset at the low end of the AM or FM band.

Basic Operation

19

ENGLISH

3. Start the automatic tuning preset by simultaneously pressing **MEMO** and **TUNE ▲** on the front panel **20 15**. The station tuned in step #2 will be entered into the tuner's memory as **CH 1**. The **MEMO 3** and **AUTOMEMO 1** indicators will flash. The display will show increasing frequencies to indicate that the auto scan is in progress.

4. Each time the tuner finds a station the scanning will pause and the station will be played for five seconds. During this time you have the following options:

a. To enter the station in the next open memory position, no action is needed. After five seconds the tuner will enter the station and the preset number will be visible at the far left side of the main information display.

b. The frequency band may be changed by pressing the **FM/AM** button **3 3**.

c. If the tuner is scanning FM stations, the **MODE** may be changed from **AUTO** to mono by pressing the **FM MODE** button **22**.

d. If you do not wish to enter the current station into the preset memory, press the **TUNE ▲** button **15 10** on the front panel or remote.

5. After the desired action is completed, or five seconds elapse, the tuner scan will continue. The operation will stop automatically when all 30 preset positions are filled or when both frequency bands have been completely tuned, whichever comes first. To stop the automatic preset process at any time press the **CLEAR** button **21** or any input selection button.

Manual Tuner Preset

Stations may be manually entered into the tuner's memory in any order. Manual entry is performed from the remote control only.

1. Tune to the desired station as outlined in Tuner Operation Section.

2. Press the **MEMO** button **20 15** and note that the **MEMO** indicator **3** will flash.

3. While the indicator is flashing for the next 5 seconds, enter a number from 1 to 30 using the number buttons on the remote **15**. Any number may be used, but if another station has already been programmed into the location number selected, the previous setting will be lost.

a. To enter a single digit memory location, press **0** before the number, or enter the number and wait a few seconds.

b. If an invalid number (other than 1–30) is entered in error, the display will flash to alert you that the entry is invalid and it will return to the previous frequency display.

4. When the preset memory has been properly programmed the **MEMO** indicator **3** will stop blinking.

Station Name Preset

In addition to identifying stations by their broadcast frequency or by the RDS system each preset station manually may be assigned a name using alphanumeric characters. This enables you to identify a station by its call letters, program format, or any other five character phrase.

To enter a station name, first preset all stations you wish to program into the tuner's memory. Then, follow these steps:

1. Tune to the desired preset station.

2. Press the **MEMO** button **20** on the front panel or **15** on the remote for more than three seconds.

3. Note that a character on the left side of the main information display will start to blink.

4. Enter the first character of the name using either the front panel **TUNE ▲** or **▼** buttons **15** or the alphanumeric buttons **15** on the remote.

A. To use the front panel buttons simply press and hold **TUNE ▲ 15** button until the desired letter or number appears. Note that the upper case alphabet will appear, followed by the numbers 1 through 0, and then a _ indicating a blank space. Tapping the button will advance the display one character at a time; holding it down will move the display quickly. If you pass by the desired character, use the **TUNE ▼ 15** to move the display in reverse.

Basic Operation

20

After entering the first character, press **MEMO** **20** to move to the next position and note that the next digit will blink. Use the same procedure outlined above to enter a character.

When you have entered a digit or "blank" in all five spaces, press **MEMO** **20** for more than 1 second to confirm the entry.

B. To use the remote for character entry, press the button corresponding to the desired letter or number. Press it once to enter the first printed letter, twice for the second, three times for the third and four times for the number. Press the "9" button to enter a blank space. (For example, press the "ABC" button once to enter an "A", three times for a "C" and four times to enter a "1".)

Use the **MEMO** button **15** to move to the next digit position. When all five spaces have been filled, press **MEMO** again for more than 1 second to confirm the entry.

Once a station name has been attached to a preset position, the station's frequency will appear briefly when the unit is tuned to that station. After a few seconds the preset name will appear in the display.

Tuning Preset Stations

Stations preset into the tuner's memory may be recalled in a number of ways.

1. To recall a station directly enter a number from 1 to 30 using the number buttons on the remote **18**.

a. To enter a single digit memory location, press **0** before the number, or enter the number and wait a few seconds.

b. If an invalid number (other than 1–30) is entered in error, that number will flash to alert you that the entry is invalid and the display will return to the previous frequency display.

2. To scan through the list of preset stations, press the **P-SET** **▲** or **P-SET** **▼** button on the front panel **13** or the **CHANNEL** buttons **◀** or **▶** on the remote **11**. Press once to move up or down through the memory presets one by one, or press and hold the button to quickly scan through the list of stations.

3. To automatically review each station in the memory, press the **P-SCAN** button **14** **14**. Note that the **P-SCAN** indicator **11** will blink.

The tuner will move up through the list of stations, pausing to play each for five seconds. Note that preset numbers where no station has been programmed will be skipped.

When the desired station is reached press **P-SCAN** **14** or **CLEAR** **21**.

Clearing Preset Stations

Once stations are programmed into the preset memories, it is possible to remove them individually or as a group.

To remove a single station from the memory:

1. Recall the station by pressing the buttons on the remote corresponding to the station's memory location.

2. Press the **MEMO** button **20** or **15** and observe that the **MEMO** indicator **3** will blink.

3. While the indicator is blinking, press the **CLEAR** button **21** (not the button **CLEAR** on the remote) within five seconds. The word **CLEAR** will show briefly to confirm that the memory position has been cleared.

To clear *all* memory locations, the volume level and surround mode memories:

1. Press the **MEMO** button **20** **15** and the **CLEAR** button **21** **13** at the same time for some seconds, until **CLEAR MEMO** appears on the display.

NOTE: When a complete memory clear is performed the AVR 70 will turn off as part of the process. After clearing the memory it is necessary to reset all stations and set up parameters.

Basic Operation

21

ENGLISH

RDS Operation

Now in use in many countries, RDS (Radio Data System) is a means of transmitting station call signs or network identification, a description of the station's programming, indication of national, regional or local programmes and others using hidden space in the FM signal. Your new receiver is equipped with RDS to assist in the selection of FM stations using station and network names, rather than broadcast frequencies. Additional RDS functions include the ability to search for programme types or to find stations with a specific programme type with a stronger signal.

Programme Service Display

When a receiver is tuned to an FM station that is transmitting RDS data, the front panel information display will automatically show the programme service, network or station name in place of the typical display of the station's broadcast frequency. To display the frequency, press the front panel **RDS DISP** button **23**.

Programme Type (PTY) Display

The RDS system categorizes programmes according to their genre into different programme type (PTY) groups. To display the programme type information of the current station, simply press the **RDS/PTY** button on either the remote control or the front panel **25 26**.

Please note that many stations don't broadcast PTY codes yet. Then **NONE** is indicated.

PTY Auto Search

Your receiver is equipped to automatically search for stations transmitting any of the fifteen different programme types. To search for a PTY, follow these steps:

1. Press the **RDS/PTY** button on either the front panel or the remote. The current station's PTY will be displayed, or the currently selected PTY group will be displayed if no station or RDS data is present.
2. To change to a new PTY type, press the **RDS/PTY** button **25 26** again until the desired PTY is shown in the display.
 - a. When PTY selection is made using the **RDS/PTY** button only, the selection uses the PTY Group shown in Table 1.
 - b. To select a specific PTY type directly, use the numeric buttons on the remote control **18** to select the programme type corresponding to the numbered choices in Table 1.
3. Once the desired PTY group or type has been selected, press the **Tune Up/Down** buttons on the front panel or remote control **15 10** while the PTY indication is blinking (within 5 seconds). The PTY Auto search will start, and the tuner will stop at the next station broadcasting RDS PTY information corresponding to the selected choice.
4. To advance to the next RDS station with the desired PTY, press the **Tune Up/Down** button again within 5 seconds.

AF Auto Search

A unique feature of the RDS system is its ability to find a station with identical programming automatically. This feature is particularly useful when listening to a national radio station where the same program is broadcast from a number of transmitters.

To search for Alternate Frequencies follow these steps:

1. Tune the receiver to the desired station using the **Tune Up/Down** buttons **15 10**.
2. Press the **RDS/AF** button on the front panel or remote control **24 27** twice within 1 second.
3. The tuner will automatically search for stations broadcasting the same program. When these stations are received, the front panel display will indicate **AF-1**. If the **RDS/AF** button is pressed again, the display will indicate the next identically programmed station by **AF-2**.
4. Press the **RDS/AF** button repeatedly until a station is indicated that has the desired high enough signal strength. When the display indicates **AF-0** the tuner has returned to the original station.

NOTE: If the front panel display indicates **NONE** after the **RDS/AF** button is pressed once, no alternate stations with the same program actually are available (not yet searched). In this case press **RDS/AF** twice within 1 second to start the AF search.



Basic Operation

22

Table 1: RDS Programme Type (PTY) Groups

<i>DISPLAY</i>	<i>PTY Button Group</i>	<i>Numeric Button</i>	<i>PTY Display Data</i>	<i>Programme Type</i>
POP		1	POP	Pop Music
		2	ROCK	Rock Music
EASY		3	MOR	Middle of the Road Music
		4	LIGHT	Light Music
CLASSIC		5	CLASSIC	Serious Classical Music
		7	NEWS	News Broadcasts
		8	AFFAIR	Political and Current
INFO		9	INFO	General information, financial and trading news, weather information
		10	SPORT	Sporting Events
		11	EDUCATE	Scholastic and industrial education programmes
		12	DRAMA	Plays and literature performances
CULTURE		13	CULTURE	Culture, religion and community programmes
		14	SCIENCE	Scientific and technical programmes
OTHER		15	OTHERS	Varied entertainment
		6	OTHER	Other musical programmes: Jazz, Reggae, Rap, etc.

On Screen Display

Master Volume

When the volume is changed, a horizontal scale will briefly appear at the bottom of the screen with the volume level. (Figure #8)

Mute

When the unit is placed in audio mute, the word MUTE will appear in the upper right corner of the screen as a reminder that the volume has been cut. (Figure #9)

On Screen Display Function

If you do not wish to have the on screen displays appear, press the SCREEN DISPLAY button **19** on the remote until OSD OFF appears on the display. A reminder message will appear on the screen for a few seconds (Figure #10), and the displays will then be canceled until they are once again activated.

Using The On Screen Menus for System Control

Besides conveying status messages, the on screen display system may also be used as a means of controlling the operation of the unit. To operate the control system, always start by pressing SELECT **18** on the remote to bring up the Main Menu. (Figure #1). Then, use the up/down navigational arrow keys **▲** and **▼** **17** to move the cursor. Press SELECT **18** to choose a menu, and then use the left/right navigational arrow keys **◀** and **▶** **17** to view the choices in that current option. Finally, when the desired choice appears, press SELECT **18** to enter the choice and return to the MAIN MENU. To exit from the Menu Control System, press **▼** **17** until the on screen > cursor is pointing to MENU OFF and press SELECT **18**.

The following functions of the AVR70 may be controlled through the Menu Control System:

INPUT SELECTION: After reaching the INPUT SELECTOR menu (Figure #11), use the arrow keys on the remote **17** to select the desired input. Remember that when a split listening session is desired, select the VIDEO source first, followed by the AUDIO source.

SURROUND MODE: After reaching the SURROUND MODE menu (Figure #12), use the navigational arrows **17** to select the desired mode. When a mode is selected that uses the surround channels, you may change the rear channel DELAY TIME at this menu.

TEST TONE: At this menu you may adjust the speaker output levels. For information on this procedure, refer to the System Configuration section of this Manual.

SET UP MENU: For information on using the Set Up menu, refer to the System Configuration section of this Manual.

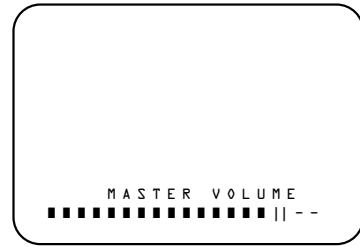

Figure 8

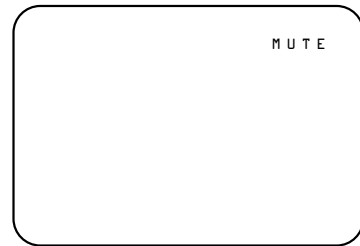

Figure 9

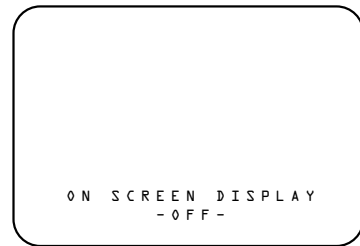

Figure 10



Figure 11

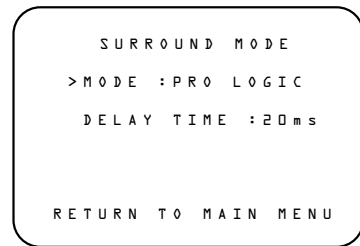

Figure 12

Advanced Features

25

ENGLISH

Audio/Video Simulcast

It is possible to listen to or record the video from one source along with the audio from a different input. This is useful in the case of musical programs where the sound is being broadcast via FM, or for sports events where you wish to have the picture from a TV station, but the play-by-play from a radio station.

To create a simulcast recording first select the video source input (**TV**, **LD**, **VCR 1**, **VCR 2**, **AUX**) using the input selection buttons on the remote control or front panel. **7 8 3** Next, select the audio source (**FM/AM**, **CD** or **TAPE 2**) **3 4 6**. Note that the on screen menu display will show the split sources (Figure # 6). The front panel display will show the audio source in large letters in the main portion of the Information Display, while the video source will appear in smaller letters next to the **VISUAL 1** indicator.

Delay Time Adjust

One aspect of the surround modes is the delay of audio signals between the front speakers and the rear speakers. Each surround mode is factory preset with a specific delay time, but it is possible to individually adjust the delay timing to custom tailor the sound to your individual taste and the acoustic conditions in your listening room or home theater.

The factory setting is appropriate for most rooms, but some installations create an uncommon distance between the front and surround speakers that may cause the arrival of front channel sounds to become disconnected from surround channel sounds.

To re-synchronize the front and surround channels, follow these steps:

1. Measure the distance from the listening/viewing position to the front speakers (in meters).
2. Measure the distance from the listening/viewing position to the surround speakers.
3. Subtract the distance to the surround speakers from the distance to the front speakers and add 5. Multiply the result with 3, the resulting number is the ideal delay time (in msec) for your room. For example, if the front speakers are 7 m away and the surround speakers are 2 m away, the formula will be $(7-2+5) \times 3 = 30$. Thus, the correct delay time in this room would be 30ms.

NOTE: The delay time may only be adjusted in certain modes.

If the delay time needs to be changed, it may be increased by pressing the **DELAY** button **11 16** on the front panel. The delay time will be briefly displayed on the video menus as well as the front panel.

In addition to the use of the delay time formula, it is a good idea to understand the features of each of the AVR70's surround modes when entering delay time. The chart on the next page provides an explanation of the suggested for each mode. The chart also contains the delay time limits for each of the modes.

Advanced Features

26

Surround Mode Chart

MODE	FEATURES	DELAY TIME RANGE
DOLBY PRO LOGIC	Dolby Pro Logic is the standard mode for surround sound decoding. It uses information encoded in a two channel stereo recording to produce four distinct channels: Left, Center, Right and Surround. Use this mode for accurate reproduction of programs bearing the Dolby Surround, DTS Stereo, UltraStereo or other "Surround" logos. Surround encoded programs include videocassette and LD movies, TV and cable programs, radio programs and audio CDs. Dolby Pro Logic processing may also be used to provide a pleasing surround effect with some source material that does not carry surround encoding.	15 ms – 30 ms Initial Setting = 20 ms
DOLBY 3 STEREO	Dolby 3 Stereo uses the information contained in a surround encoded or stereophonic program to create center channel information. In addition, the information that is normally sent to the rear channel surround speakers is carefully mixed in with the front left and right channels for increased realism. Use this mode when you have a center channel speaker, but no surround speakers.	No Surround Channels
MOVIE SURROUND	Movie Surround uses decoding similar to Pro Logic, but it permits delay times up to 90 ms. Use this mode instead of Pro Logic to experiment with surround times above 30 ms, or if the delay time formula suggests a larger time delay for your room.	10 ms – 90 ms Initial Setting = 20 ms
HALL SURROUND	This mode is designed for use with stereo recordings. It provides a sound field effect that simulates the complex combination of direct and reflected sounds that create the rich reverberant atmosphere of a medium sized circular concert hall.	10 ms – 90 ms Initial Setting = 20 ms
MATRIX SURROUND	This mode is designed for use with sports broadcasts, live concerts or other programs where the feeling of a wide surround effect is desired.	10 ms – 90 ms Initial Setting = 20 ms
STEREO	This mode turns off all surround processing and presents the pure left and right channel presentation of two channel stereo programs.	No Surround Channels

Troubleshooting

Troubleshooting Chart

<i>SYMPTOM</i>	<i>CAUSE</i>	<i>SOLUTION</i>
No front panel lights when power switch is pressed	<ul style="list-style-type: none"> • No AC Power 	<ul style="list-style-type: none"> • Make certain AC power cord is plugged into a live outlet. • Check to see if outlet is switch controlled.
Display lights, but no sound or picture	<ul style="list-style-type: none"> • Intermittent input connections • MUTE is on • Volume control is down 	<ul style="list-style-type: none"> • Make certain that all input and speaker connections are secure. • Press MUTE button. • Turn up volume control.
No sound from surround or center speakers	<ul style="list-style-type: none"> • Incorrect surround mode • Input is monaural • Incorrect configuration 	<ul style="list-style-type: none"> • Select a mode other than Dolby 3 Stereo, Stereo or Monaural. • There is no surround information from mono sources. • Check configuration in the SET UP MENU.
No On Screen Control Menus	<ul style="list-style-type: none"> • TV input is "S" Video 	<ul style="list-style-type: none"> • Change TV input to Composite Video. The menus are available ONLY on Composite Video.
Unit does not respond to remote commands	<ul style="list-style-type: none"> • Weak batteries in remote • Remote is in LEARN position • Remote sensor is obscured 	<ul style="list-style-type: none"> • Change remote batteries. • Slide USE/LEARN switch to USE. • Make certain front panel sensor is visible to remote.
Intermittent buzzing in tuner	<ul style="list-style-type: none"> • Local interference 	<ul style="list-style-type: none"> • Move unit or antenna away from computers, fluorescent lights, TVs, motors or other electrical appliances.

Memory Backup

This product is equipped with a memory backup system that preserves tuner presets and system configuration information if the unit is accidentally unplugged or subject to a power outage. This memory will last for approximately one week, after which time all information must be re-entered.

System Reset

In the rare case where the unit's operation or the displays seem abnormal, the cause

may involve the erratic operation of the system's memory or microprocessor.

To correct this problem, first unplug the unit from the AC wall outlet and wait at least three minutes. After the pause, reconnect the AC power cord and check the unit's operation. If the system still malfunctions, a system reset may clear the problem.

To clear the system's memory, press and hold the **MEMO** **20** and **CLEAR** **21** buttons at the same time for a few

seconds. After clearing the memory it will be necessary to re-establish all system configuration information and tuner presets.

If the system is still operating incorrectly, there may have been an electrostatic discharge or severe AC line interference that has corrupted the memory or microprocessor.

If a reset does not solve the problem, consult an authorized Harman Kardon service depot.

Technical Specifications

Audio Section

Stereo Mode
 Continuous Average Power (FTC)
 80 Watts per channel 20Hz–20kHz:
 @ < 0.09% THD, both channels driven into 8 Ohms

Five Channel Surround Mode
 Continuous average power per channel (FTC)
 Front L&R channels:
 70 Watts per channel from 20Hz–20kHz,
 @ < 0.15% THD, both channels driven into 8 Ohms

Center channel:
 70 Watts from 20Hz–20kHz,
 @ < 0.15% THD, driven into 8 Ohms

Surround channels:
 25 Watts per channel from 40Hz–20kHz,
 @ < 0.15% THD, both channels driven into 8 Ohms

Input Sensitivity/Impedance
 Linear 220mV/50 Kohms

Signal to Noise Rate (IHF-A)
 Linear 95 dB

Dolby Surround
 Channel Separation 40dB

FM Tuner Section

Frequency Range 87.5–108.0MHz
 Usable Sensitivity IHF 1.3 μV/13.5dBf
 Signal to Noise Ratio Mono/Stereo 76/68dB
 Distortion Mono/Stereo 0.2/0.5%
 Stereo Separation 1 kHz 40dB
 Alternate Channel
 Selectivity (±300kHz) 55dB
 Image Rejection 98MHz: 70dB

AM Tuner Section

Frequency Range 531–1602/152–282kHz
 Signal-to-Noise Ratio 50dB
 Usable Sensitivity Loop: 500μV (MW)/1,500 μV (LW)
 Distortion 1kHz, 30% Mod: 0.5%
 Selectivity ±18kHz 70dB

Video Section

Television Format PAL, SECAM, NTSC
 Input Level/Impedance 1Vp-p/75ohms
 Output Level/Impedance 1Vp-p/75ohms
 Video Frequency Response 10Hz to 8MHz (–3dB)
 S/N 65dB

General

Power Requirement AC 230V 50Hz
 Power Consumption 40W idle, 530W maximum
 Dimension (Max)
 Width 440 mm (17.4 inches)
 Height 160 mm (6.4 inches)
 Depth 459 mm (18 inches)
 Weight 12.3 kg (27 lbs.)

All features and specifications are subject to change without notice.
 Manufactured under license from Dolby Laboratories Licensing Corporation.
 Additionally licensed under one or more of the following patents:
 U.S. numbers 3,632,886, 3,746,792 and 3,959,590;
 Canadian numbers 1,004,603 and 1,037,877.
 "Dolby" and the double-D symbol **DD** are registered trademarks
 of Dolby Laboratories Licensing Corporation.